

For standby power supplies
 Expected trickle life: 6 years at 25°C
 10 years at 20°C

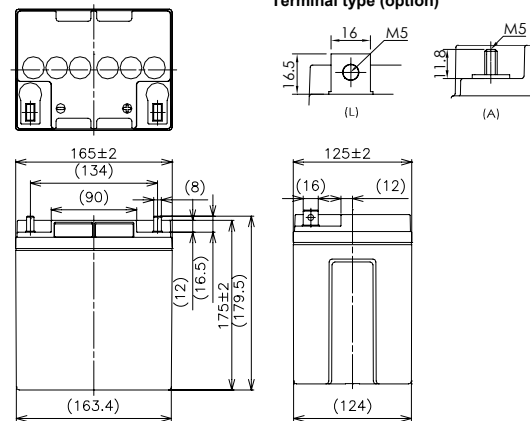

※Contents indicated (including the recycle marking, etc) are subject to change without notice.

■Dimensions(mm)



Battery case resin: Flame-retardant (UL94V-0)

■Specification

Nominal Voltage		12V
Rated Capacity(20HR)		24Ah
Dimensions	Length	165 mm
	Width	125 mm
	Height	175 mm
	Total height	175 mm/179.5mm
Approx. Mass		8.05 kg
Terminal		M5 threaded post

■Characteristics

Capacity (25 °C)	20 hour rate	24Ah
	10 hour rate	22Ah
	3 hour rate	18Ah
	1 hour rate	14Ah
Internal Resistance (25 °C)	Fully charged battery	11 mΩ
Temperature Dependency of Capacity (20 hour rate)	40 °C	102%
	25 °C	100%
	0 °C	85%
	-15 °C	65%
Self Discharge (25 °C)	After 3 months	91%
	After 6 months	82%
	After 12 months	64%

■Duration of discharge vs. discharge current

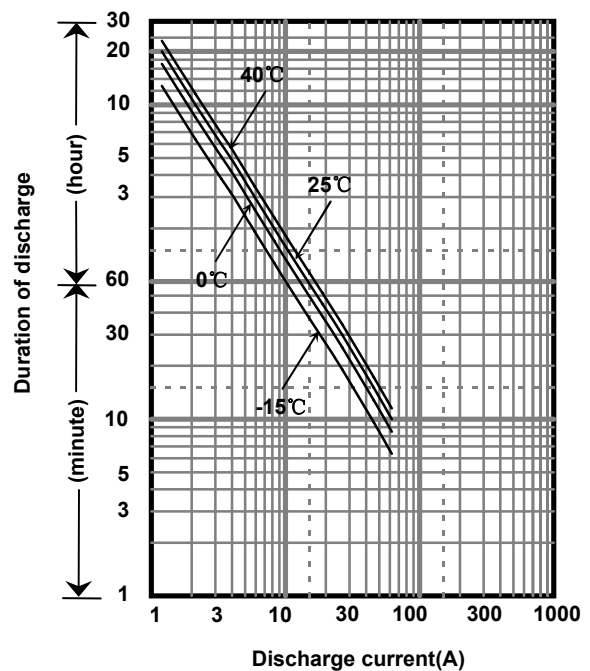

■Watt Table(25°C)

Cut-off V	(Wattage/Battery)														
	5min	10min	15min	20min	30min	45min	1h	1.5h	2h	3h	4h	5h	6h	10h	20h
9.6V	992	739	523	441	317	234	183	118	104	73.8	58.6	47.9	40.8	26.4	14.6
9.9V	931	724	520	434	314	232	181	116	103	73.4	58.2	47.5	40.6	26.3	14.6
10.2V	872	706	509	426	310	230	179	113	101	72.7	57.8	47.2	40.3	26.0	14.5
10.5V	782	654	474	405	303	226	175	111	97.2	71.6	57.4	46.8	39.8	25.9	14.4
10.8V	691	583	442	394	293	223	172	108	92.6	70.1	56.6	45.6	39.2	25.6	14.3

■Ampere Table(25°C)

Cut-off V	(Ampere/Battery)														
	5min	10min	15min	20min	30min	45min	1h	1.5h	2h	3h	4h	5h	6h	10h	20h
9.6V	89.0	66.0	45.5	38.0	27.1	19.9	14.6	10.0	8.80	6.20	4.90	3.89	3.40	2.27	1.23
9.9V	83.5	64.7	45.2	37.4	26.8	19.8	14.5	9.80	8.73	6.17	4.87	3.86	3.39	2.26	1.22
10.2V	78.2	63.0	44.3	36.8	26.5	19.6	14.3	9.60	8.51	6.11	4.84	3.83	3.36	2.23	1.21
10.5V	70.1	58.4	41.2	34.9	25.9	19.3	14.0	9.40	8.21	6.01	4.80	3.80	3.32	2.22	1.20
10.8V	62.0	52.1	38.4	34.0	25.0	19.0	13.7	9.14	7.82	5.89	4.74	3.71	3.27	2.20	1.19

Charging Method (25°C)

Trickle use	Control voltage:13.6-13.8V Initial current:3.60A or smaller
-------------	--

Cut off voltage

Discharge current	1.20A-4.80A	4.80A-12.0A	12.0A-24.0A	24.0A-48.0A	48.0A-72.0A
Cut off voltage(V)	10.5	10.2	9.9	9.3	8.7

Influence of Temperature on Trickle life

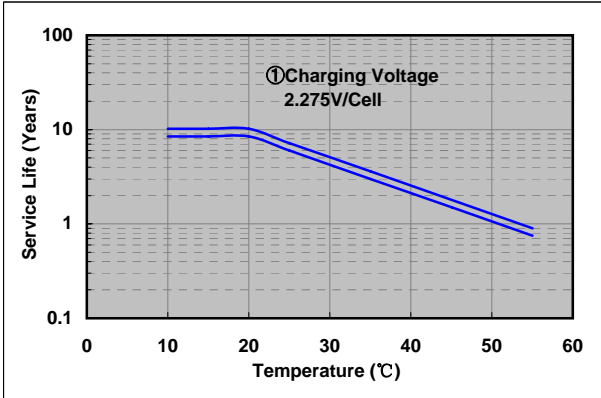

Residual capacity test result

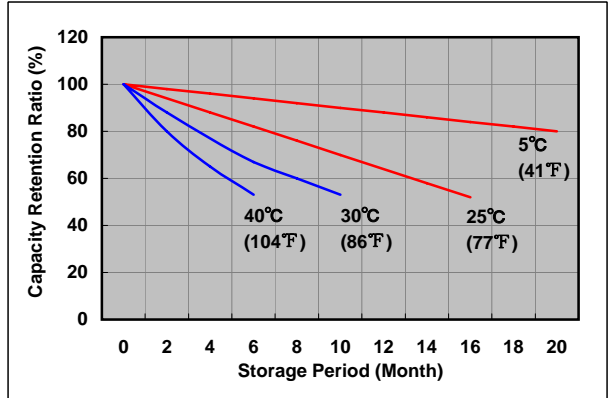

Constant-voltage constant-current charge characteristics for Trickle use

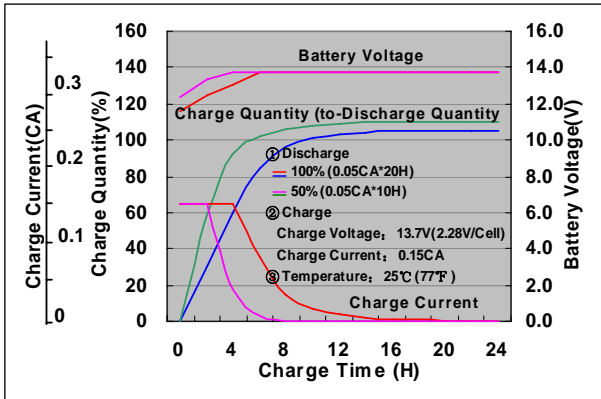

Discharge capacity by temperature and by discharge current

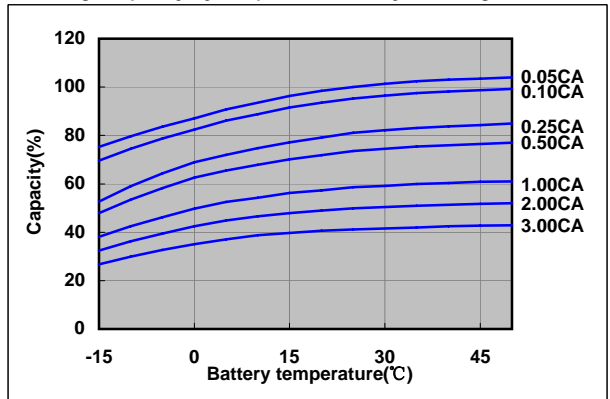

Discharge characteristics(25°C)

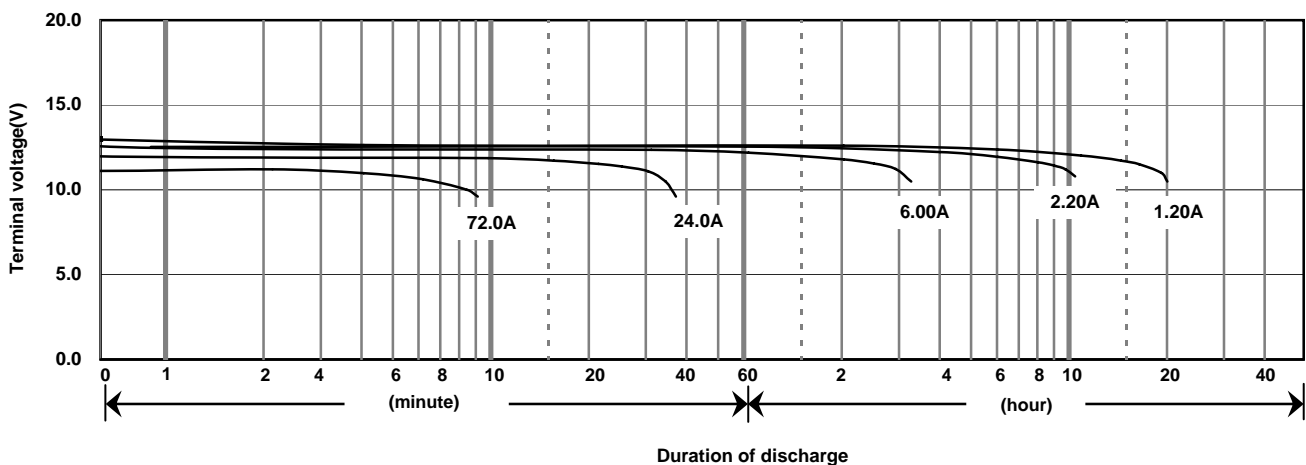

Caution

Due to the potential energy stored in the batteries, Please read «Precautions for handling the Rechargeable Valve Regulated Lead Acid Batteries» before using batteries. If improper handling or use of the batteries without understanding «Precautions for handling the Rechargeable Valve Regulated Lead Acid Batteries» may result in bodily injury caused by electrolyte leakage, heat generation, or explosion.

Panasonic Storage Battery (Shenyang) Co., Ltd

NO. 51 Kunminghu Street, Shenyang Economic & Technical Development Zone, 110141 China
 Tel: 86 24 25818921
 Fax: 86 24 62786318
 Website: <http://www.panasonicbattery.cn>

2010.03

Mouser Electronics

Authorized Distributor

Click to View Pricing, Inventory, Delivery & Lifecycle Information:

[Panasonic:](#)

[LC-P1224P](#)