

Bose Work

CONFERENCING, CLARIFIED.

C O V I D - 1 9 H A S J O I N E D T H E M E E T I N G

COVID-19: Accelerated change

Video Conferencing Software Market Report on Global and USA Industry- Covid-19 Impact, Manufacturers, Future Development, Demands, Trends, Share, Size and Forecasts

By ganesh.pardeshi | 17th August 2020



Video Conferencing Software Industry 2020 Market Research Report* A new report added by DeepResearchReports.com to its research database. Video Conferencing Software Market is segmented by Regions/Countries. All the key market aspects that influence the Video Conferencing Software market currently and will have an impact on it have been assessed and propounded in the Video Conferencing Software market research status and development trends reviewed in the new report.

Working from home isn't going away. Here's how to invest in it with ETFs

Published: Aug. 17, 2020 at 10:00 a.m. ET

By Andrea Rigauer

Look beyond the obvious ticker, WFH, to the themes underpinning the trend



Referenced Symbols

SKYY +0.98% ▲ CLOU +1.77% ▲ SRVR +1.36% ▲ WCLD +2.27% ▲ CIBR +0.37% ▲ HACK +0.02% ▲ IHAK +0.54% ▲ BUG +0.81% ▲ WFH +0.94% ▲



5 Solutions to Your Biggest Work-From-Home Challenges

Collaboration can be difficult when employees are spread out, but it doesn't have to be.



Add to Queue

NEXT ARTICLE

Adaptable & Flexible Conferencing and Connection

More Rooms
More Video



Emergence of
Hybrid Work



Additional Temporary
Spaces



The Contactless
Meeting Room



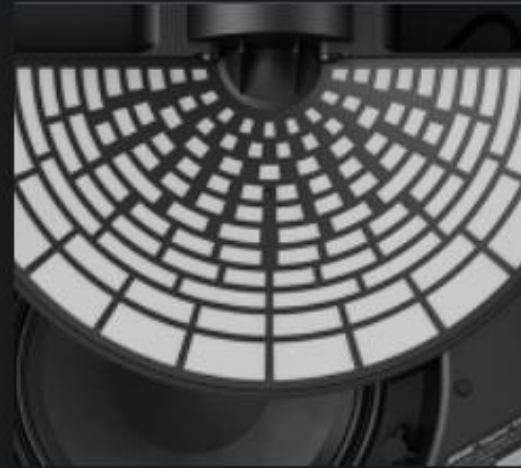

Bose Work

CONFERRING, CLARIFIED.

Work, better.

Technology and tools that benefit users in any “office”

Bring the simplicity and clarity of Bose to conferencing and unified communications

Complement popular UC cloud services, including Microsoft Teams, Google Meet, Zoom, and more

Include practical management and analytics tools



A Known and Trusted Brand

Bose products are recognized as a premium brand.

It's a global brand known for quality audio, simplicity, and solving real problems

Bose products provide:

- The clarity and simplicity users expect from Bose, now for work life
- Ease of use and reliability, reducing your call volume
- Ease of deployment and management



GLOBAL CONSULTANCY [PROPHET](#) ANNOUNCED THE RESULTS OF THE FIFTH [PROPHET BRAND RELEVANCE INDEX®](#) (BRI), A RANKING OF THE MOST RELEVANT BRANDS OF TODAY BASED ON CONSUMER FEEDBACK.

INTEGRATED
MEETING ROOMS



Design fully
integrated
meeting rooms.

ALL-IN-ONE
SOLUTION



Simplify huddle
spaces and medium-
sized conference
rooms with an
all-in-one solution.

DESKTOP & MOBILE
CONFERENCING



Help remote and
open-office workers
feel more engaged.



BOSE VIDEOBAR™ VB1

Feel more connected and engaged.

The Bose experience

Conversation that's more natural for all
participants

Communicate and be seen more clearly

Certified, works with UC platforms such as
Microsoft Teams, Google Meet, Zoom
and more



BOSE VIDEOBAR™ VB1



Voice pickup
out to 6
meters (20
feet)



4K, wide FOV
and images
up to 20 feet



Premium
audio
playback



Slim, low-
profile
design



Single-cable
USB connectivity



Remote
management

MEDIUM-SIZED ROOM | HUDDLE SPACE



Voice Pick-up - Medium Rooms

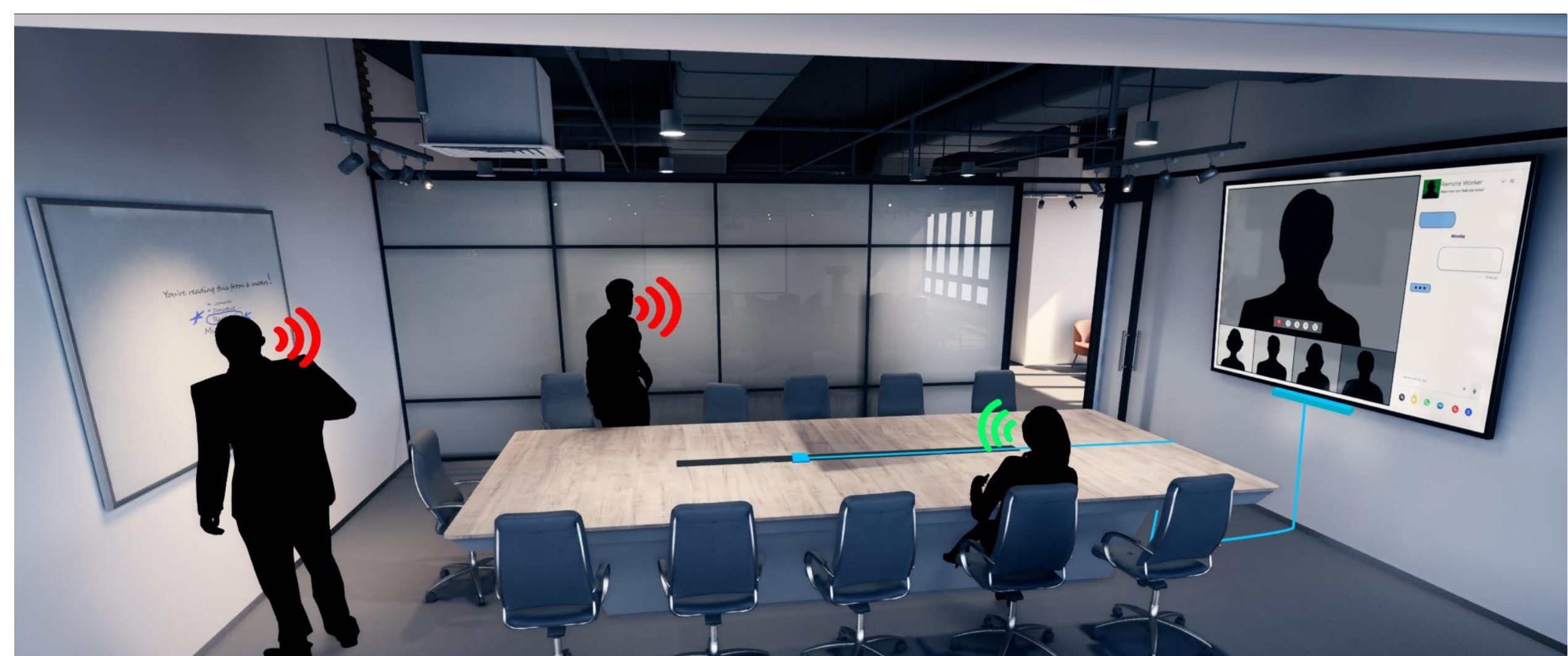

Voice Pick-up - Medium Rooms

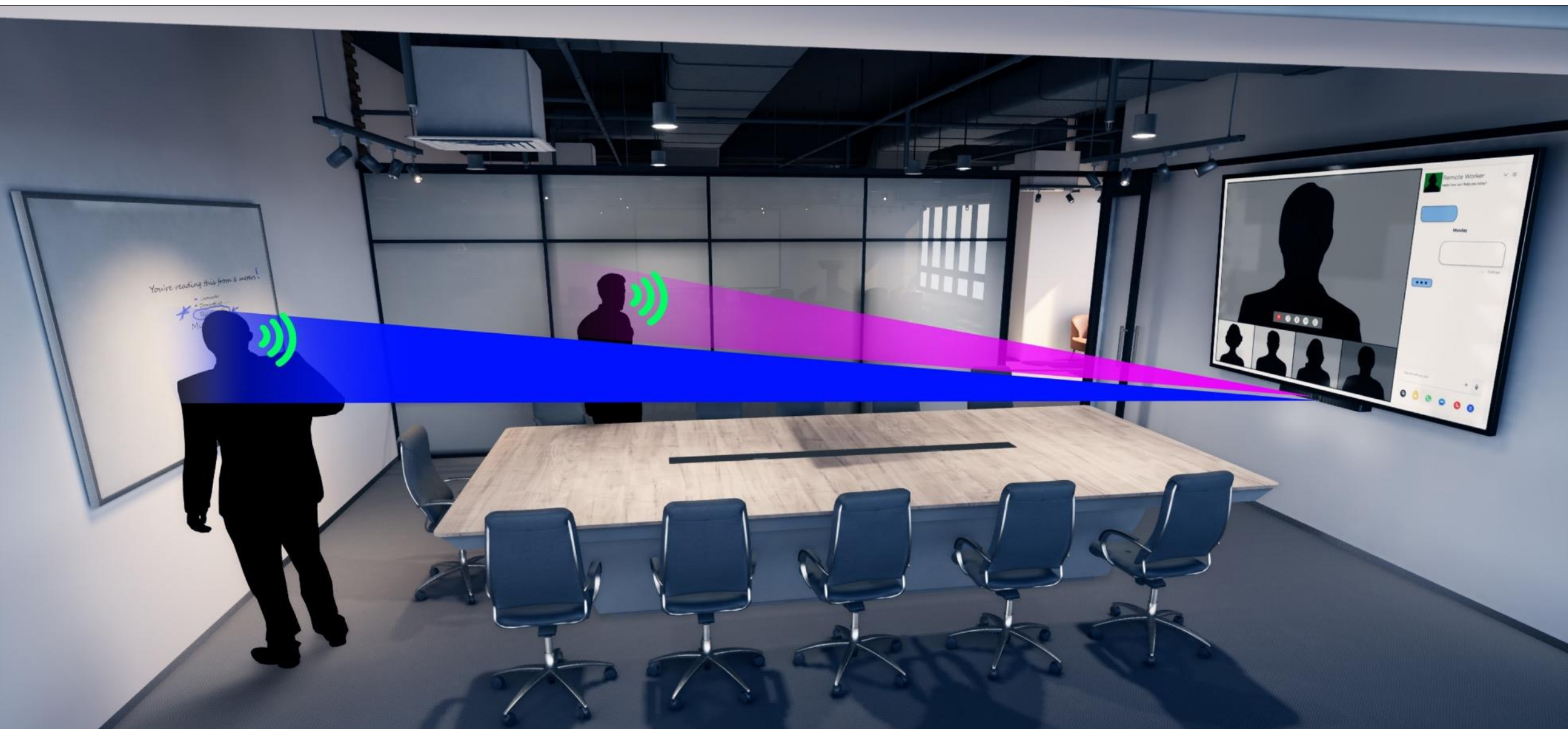

Six wideband microphones
Up to 6m (20') pickup
Narrow mic beams reduce reverb

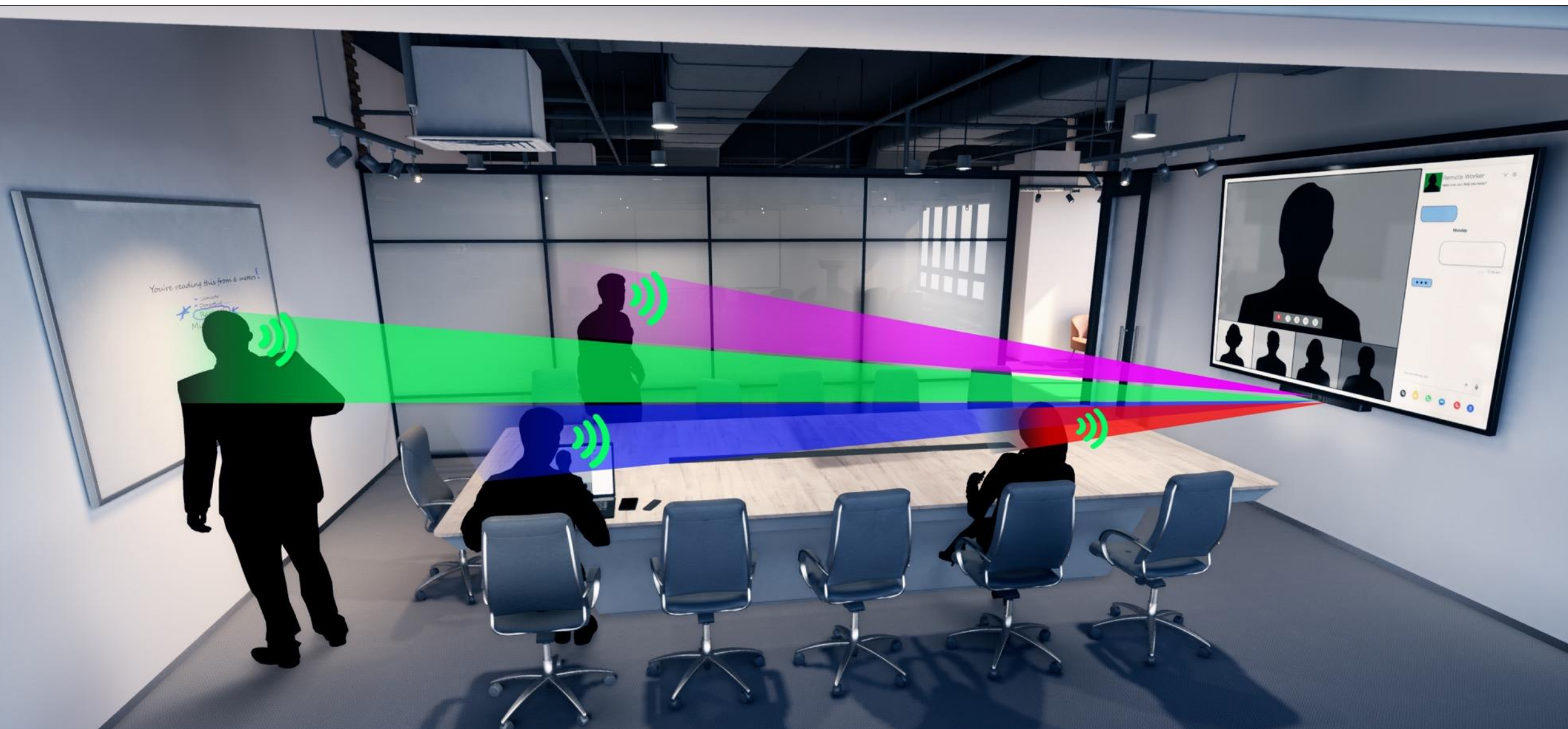

4 dynamic microphone beams

Natural conversation

Clean Table

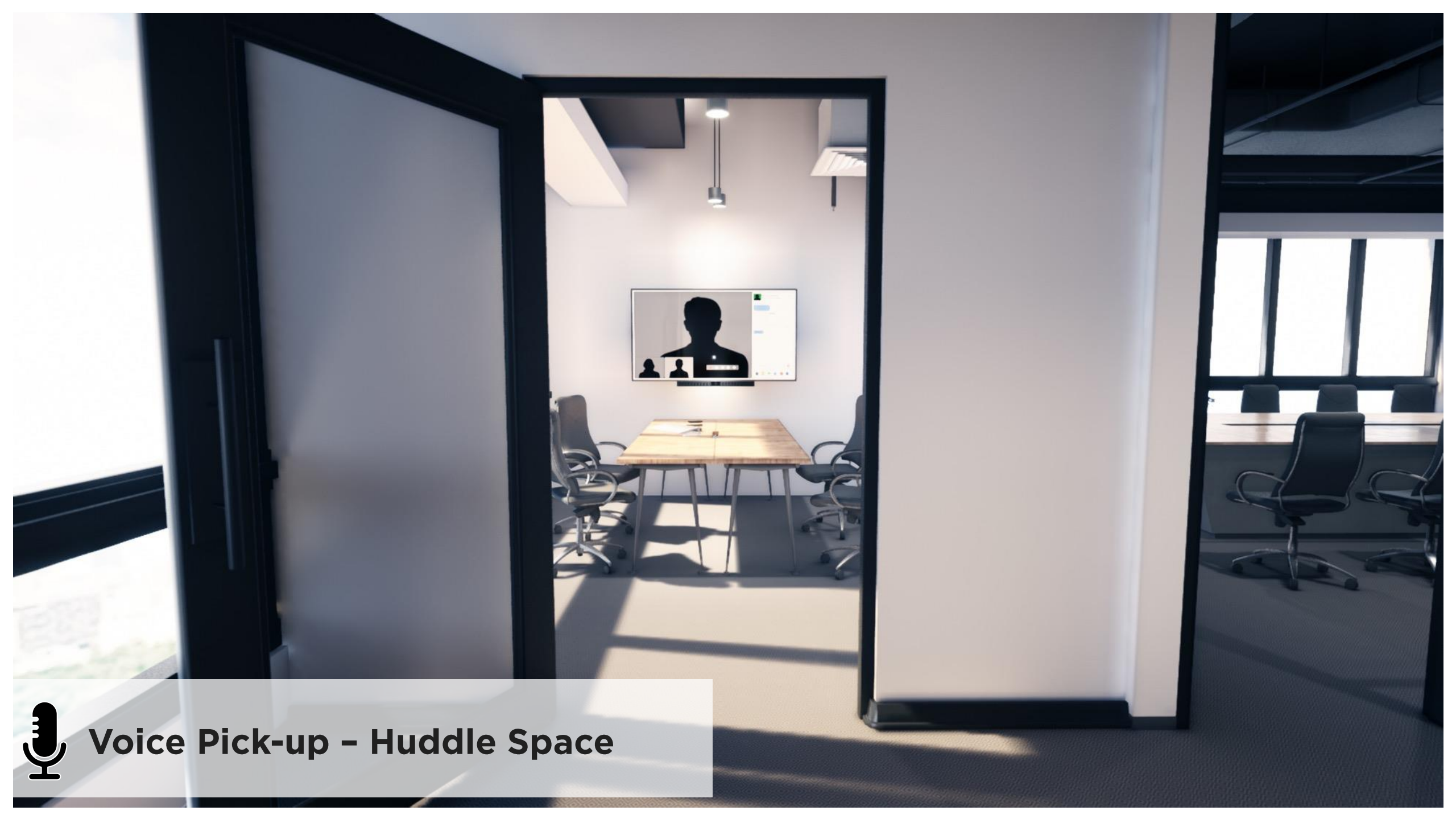

Voice Pick-up - Huddle Space

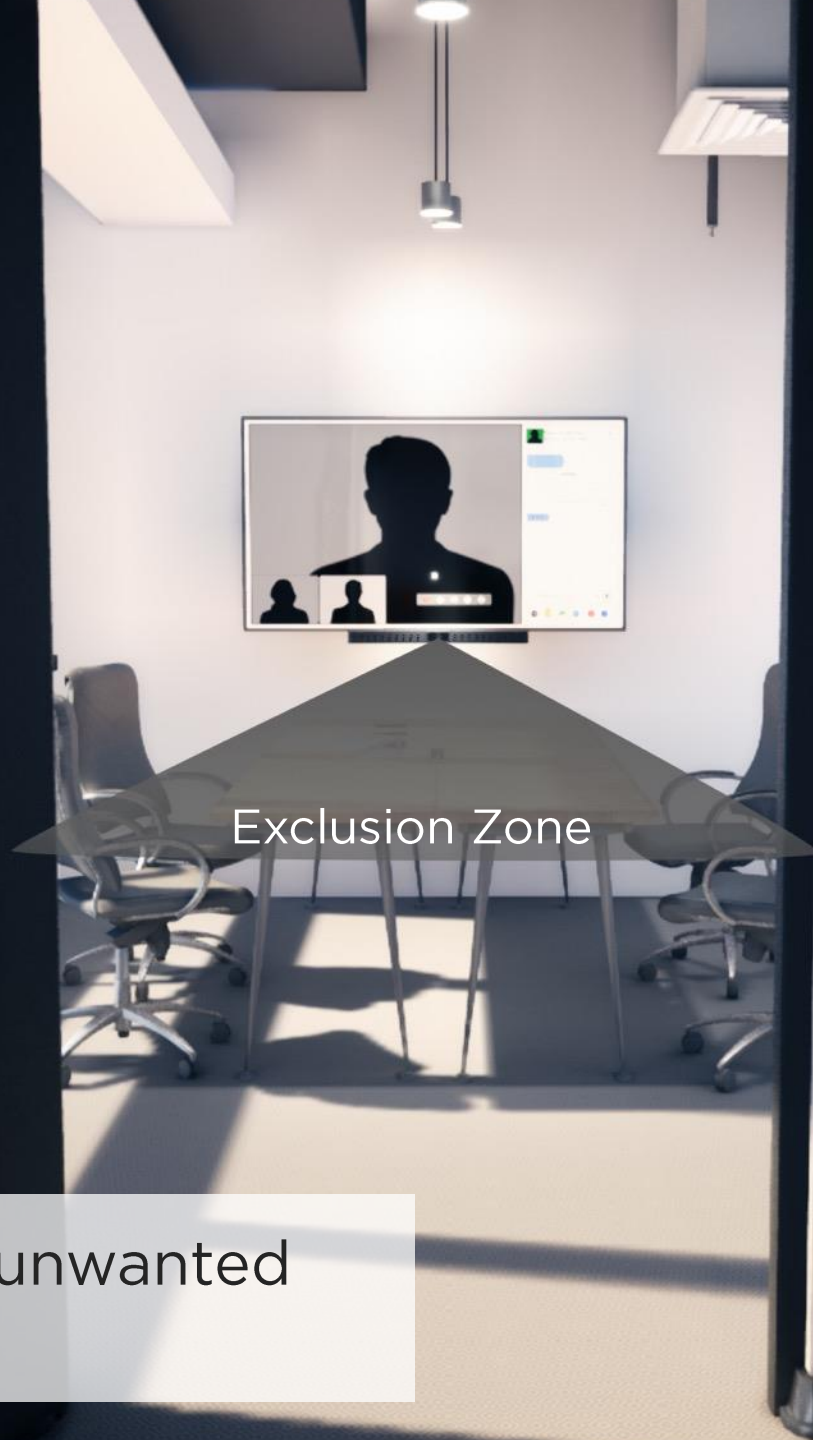

Exclusion Zone



Exclusion Zone block unwanted sounds



Voice Pick-up - Meeting Booth

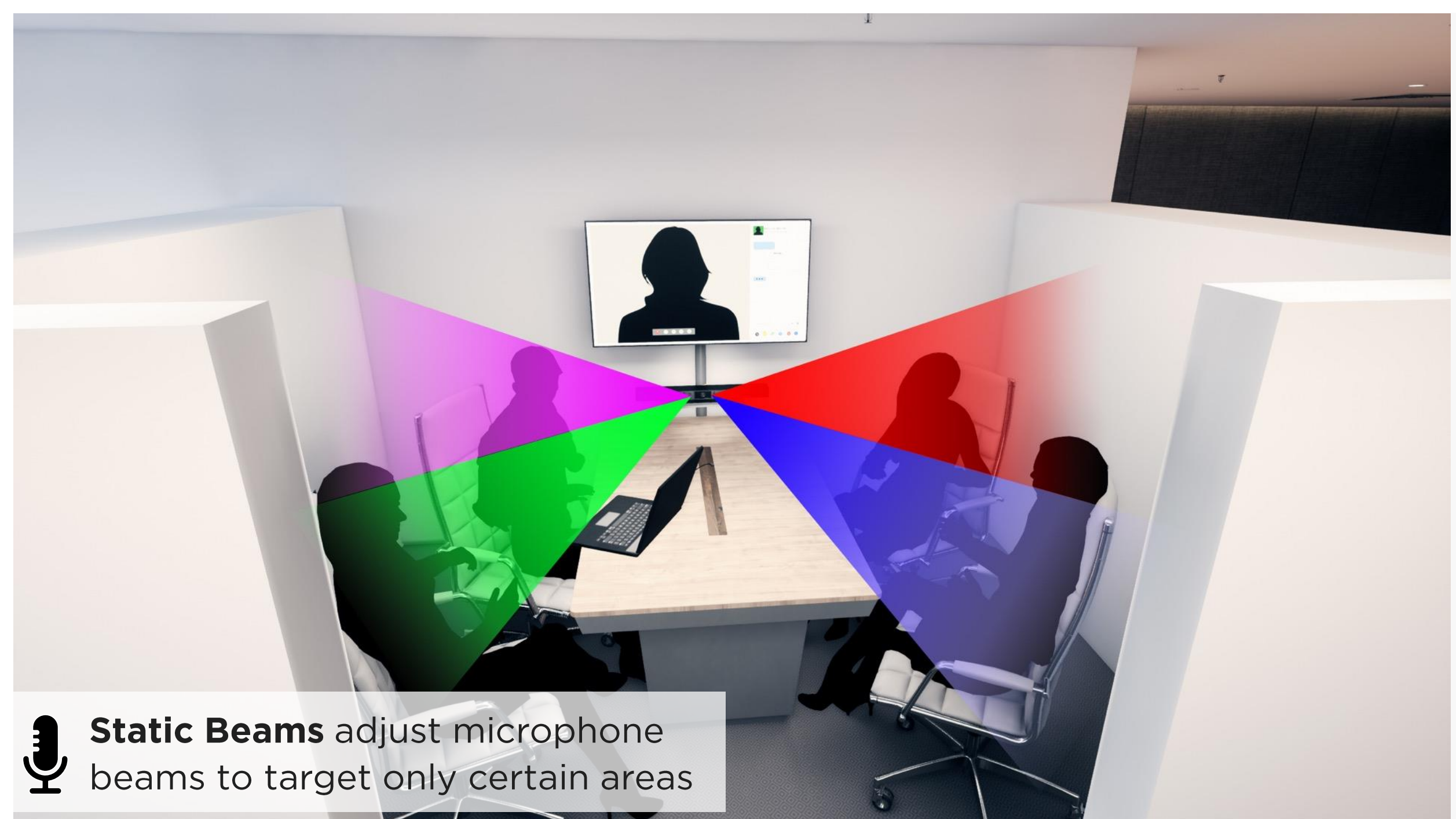

Static Beams adjust microphone beams to target only certain areas



DEMONSTRATION

THE CAMERA





Field-of-View

Horizontal 115, Diagonal 123



Autoframing

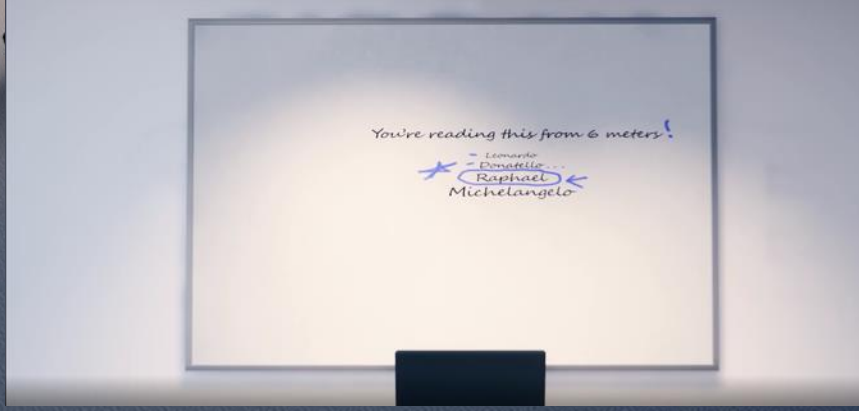



DEMONSTRATION

 **Audio Playback**



Yawed inward to lock voices to the display

6 element beamforming microphone array

2 Race-track drivers



Low-profile Design

27"

3.8"

1.9"







Connectivity





Connectivity

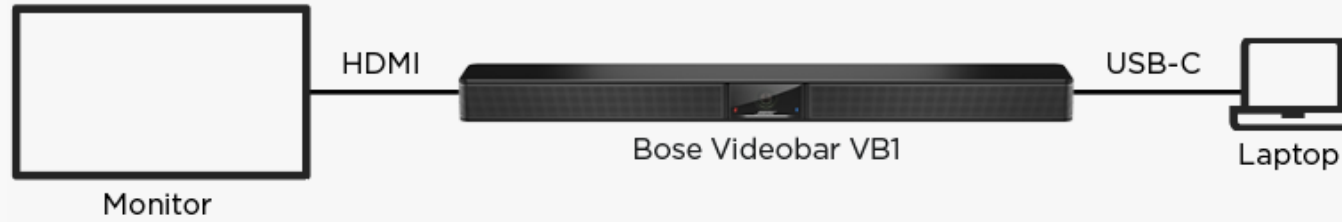

BYOD – UC Collaboration Software on Laptop

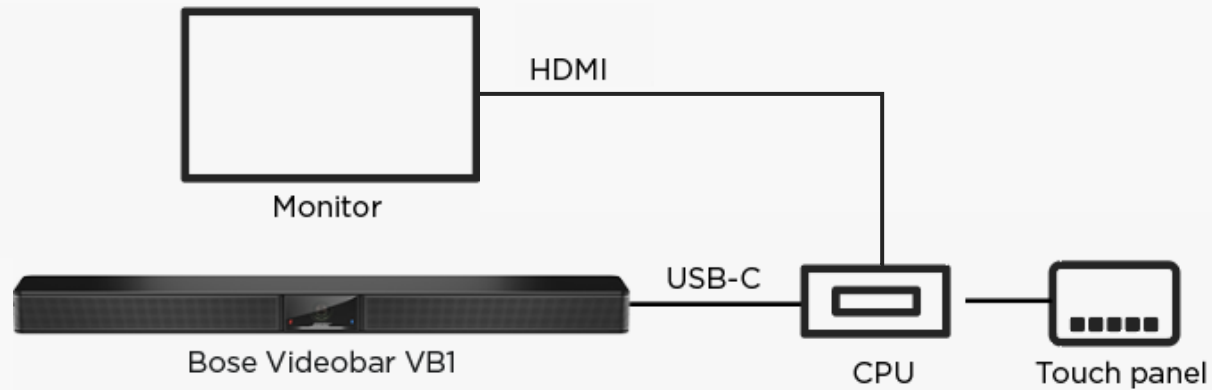

UC Collaboration Software on CPU in Conference Room



Connectivity

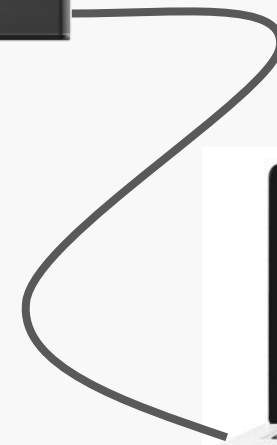
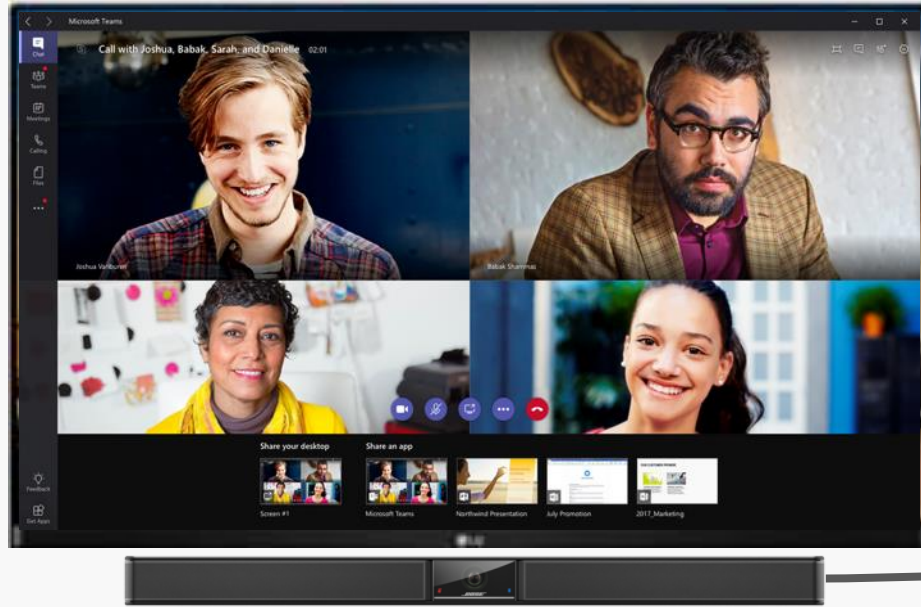

One-cable Meetings



Remote Management

Bose Work mobile app for Android and iOS gives users real-time control of volume, mute, pan, tilt, zoom, zoom presets, and Bluetooth® pairing.



Bose Work configuration software for Windows, macOS, or via web browser simplifies setup and configuration.

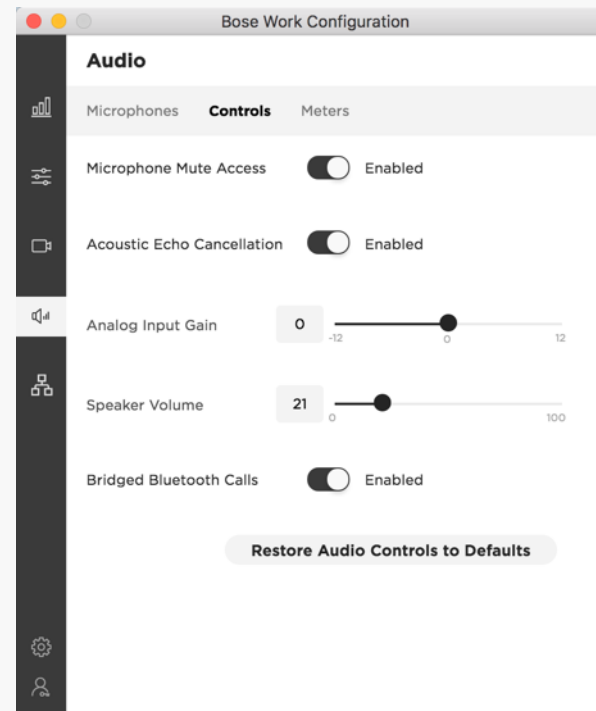

Bose Work management software for Windows makes it simple to deploy and manage the Bose VideoBar™ VB1 anywhere- from an individual device to enterprise-scale numbers across the globe.

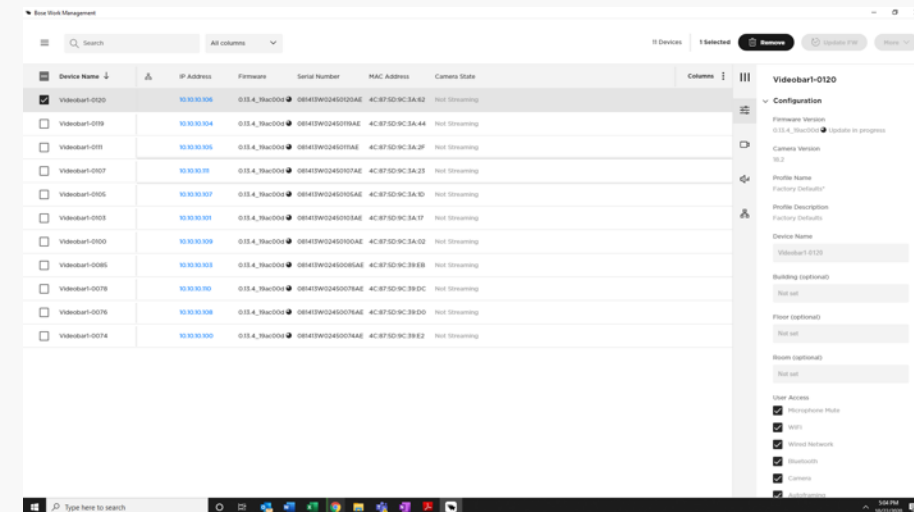



DEMONSTRATION

Bose Videobar™ VB1 Optional Accessories

Display Mounting Kit



**Bose Videobar™ VB1
Optional Accessories**

Right-angle USB 3.1 Cable



Get Started Now!
Take a test Drive...



**BOSE
NOISE CANCELLING
HEADPHONES
700 UC**

**Turn any space
into a meeting place.**

Speak confidently and be heard clearly on conference calls without a boom microphone in your way.

Personalize your work environment with 11 levels of noise cancellation.

Stay reliably connected and easily switch between audio sources.



BOSE NOISE CANCELLING
HEADPHONES 700 UC

Built for the UC Experience

Certified for Microsoft Teams

Compatible with Zoom

Works with Google Meet

Easily join Microsoft Teams meetings with the dedicated Teams button, which also brings your Teams window to the front instantly on a Windows PC.

Configure for one-button access to Amazon Alexa or Google Assistant, plus easily manage volume, calls, and music using intuitive touch-sensitive controls.





Work Better, Wherever

HOW IT WORKS





DEMONSTRATION

INTEGRATED MEETING ROOMS



CLEAR THE TABLE FOR BETTER COLLABORATION.

Complete audio conferencing systems for fully integrated meeting rooms

Combining:

- Bose loudspeakers
- Sennheiser TeamConnect Ceiling 2 microphone
- Bose amplifier and DSP

Complete audio solutions for quick deployment and configuration

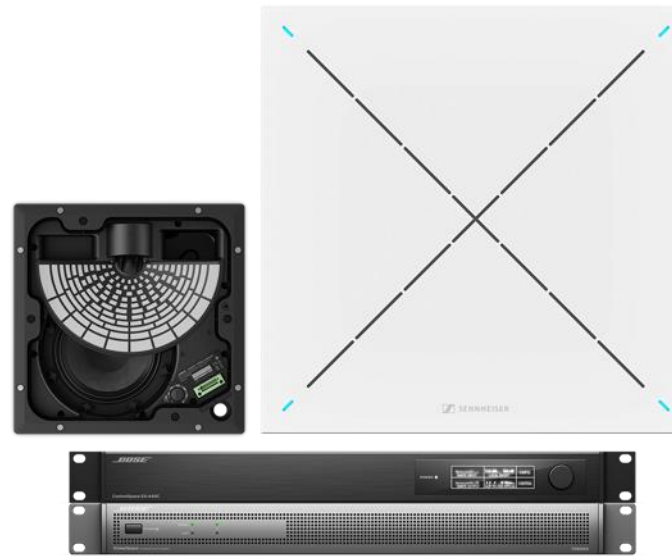

ES1



Compatible with **zoom**

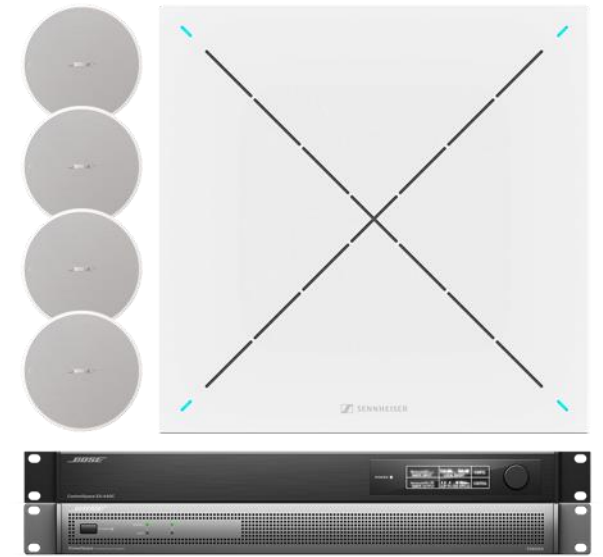

DS4



Bose ES1 Ceiling Audio Solution

Microsoft Teams certified

**Certified for use with Avaya® and Cisco®
VoIP systems**

Integrated premium conferencing solution

- EdgeMax EM180 loudspeaker
- Sennheiser TeamConnect Ceiling 2 microphone
- Bose amplifier and DSP

Fewer devices and clutter — focus on work

Clarity and intelligibility in large rooms

Deploy quickly

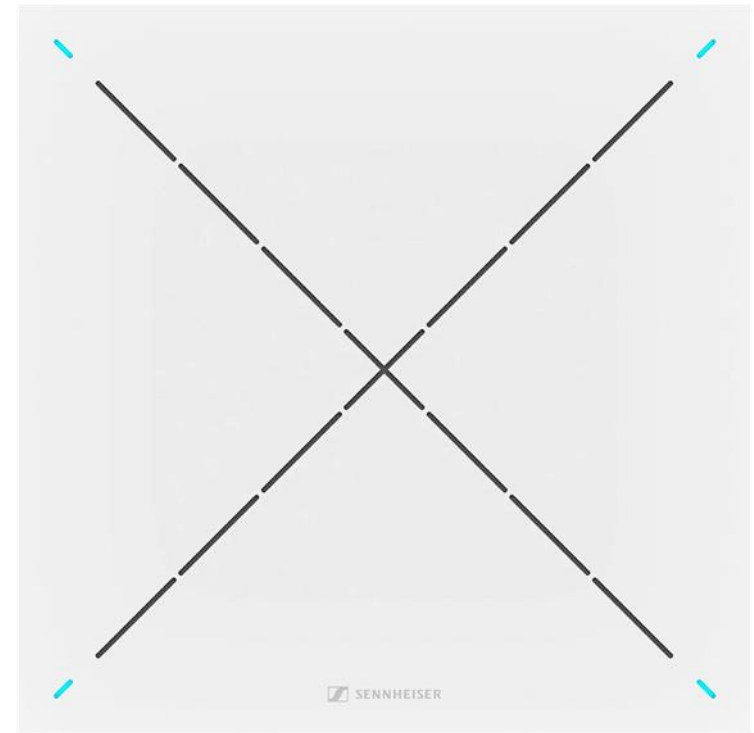

Compatible with **zoom**

EdgeMax
In-Ceiling Premium Loudspeaker



EM180

Ceiling Speaker Systems

Ceiling speakers are distributed across multiple positions.

Audio comes from overhead which is unnatural and fatiguing.

Traditional Ceiling Loudspeaker Systems

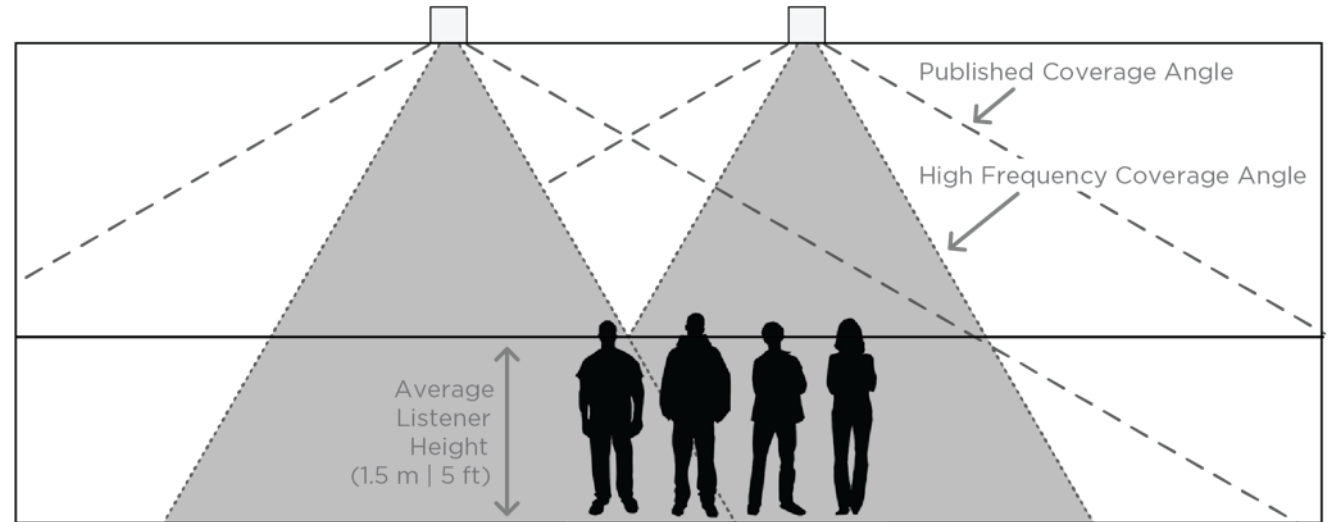

EdgeMax A more natural meeting experience

Patented PhaseGuide technology

Draws the listeners' attention toward the display

Traditional Ceiling Loudspeaker Systems

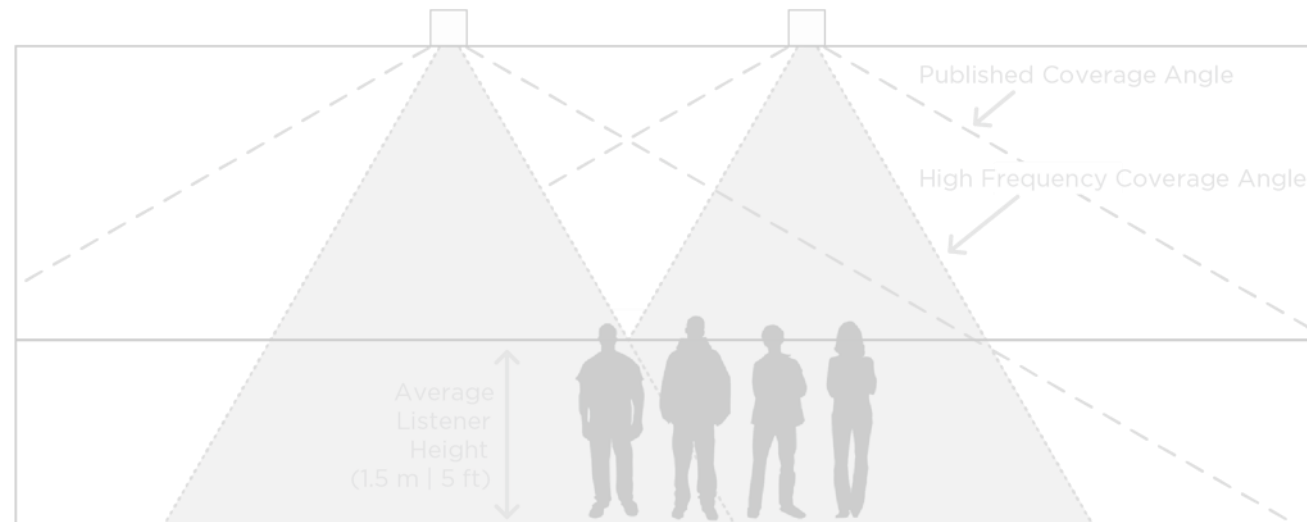

Bose EdgeMax Loudspeaker

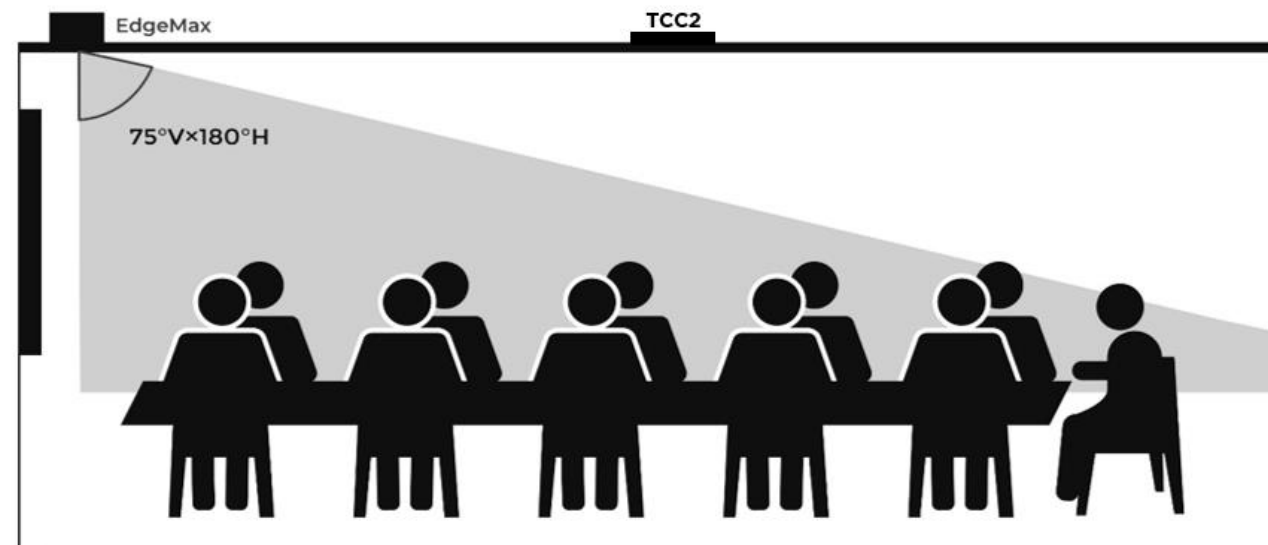

Conference Room Applications

Medium Conference Rooms

In medium conference rooms a single EM180 can be used above the screen location can provide both speech and program material reinforcement.

ES1 base system

Medium Conference Room

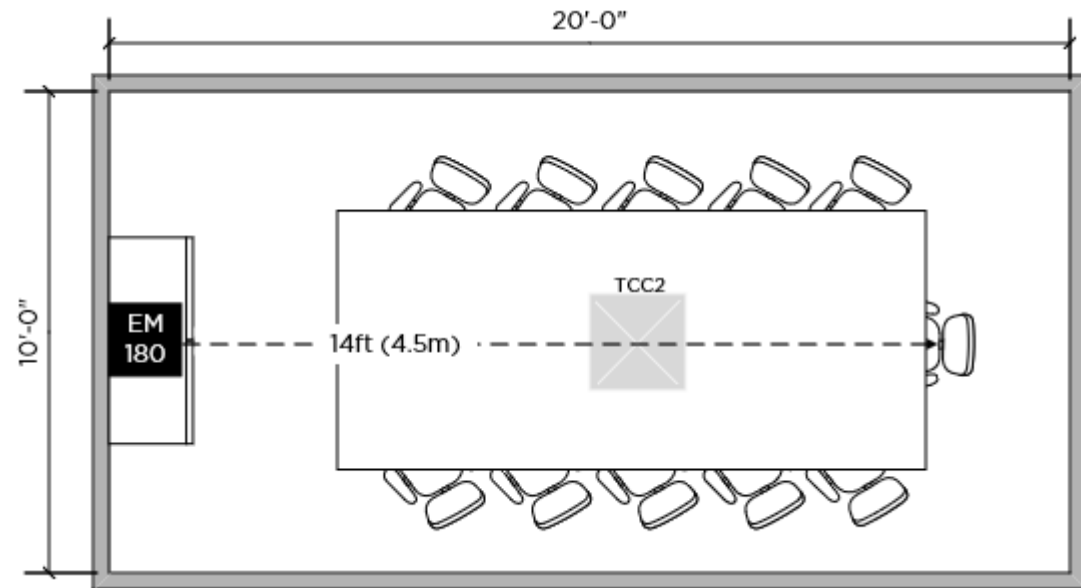

10ft Ceiling

Maximum distance to farthest listener: 4.5m (14ft)

Conference Room Applications

Large Conference Rooms

In Large sized conference rooms a single EM180 is used above the screen location, and additional EM180s along the edges provide reinforcement for audio and video conferencing.

ES1 base system + 2 EM180s

Large Conference Room

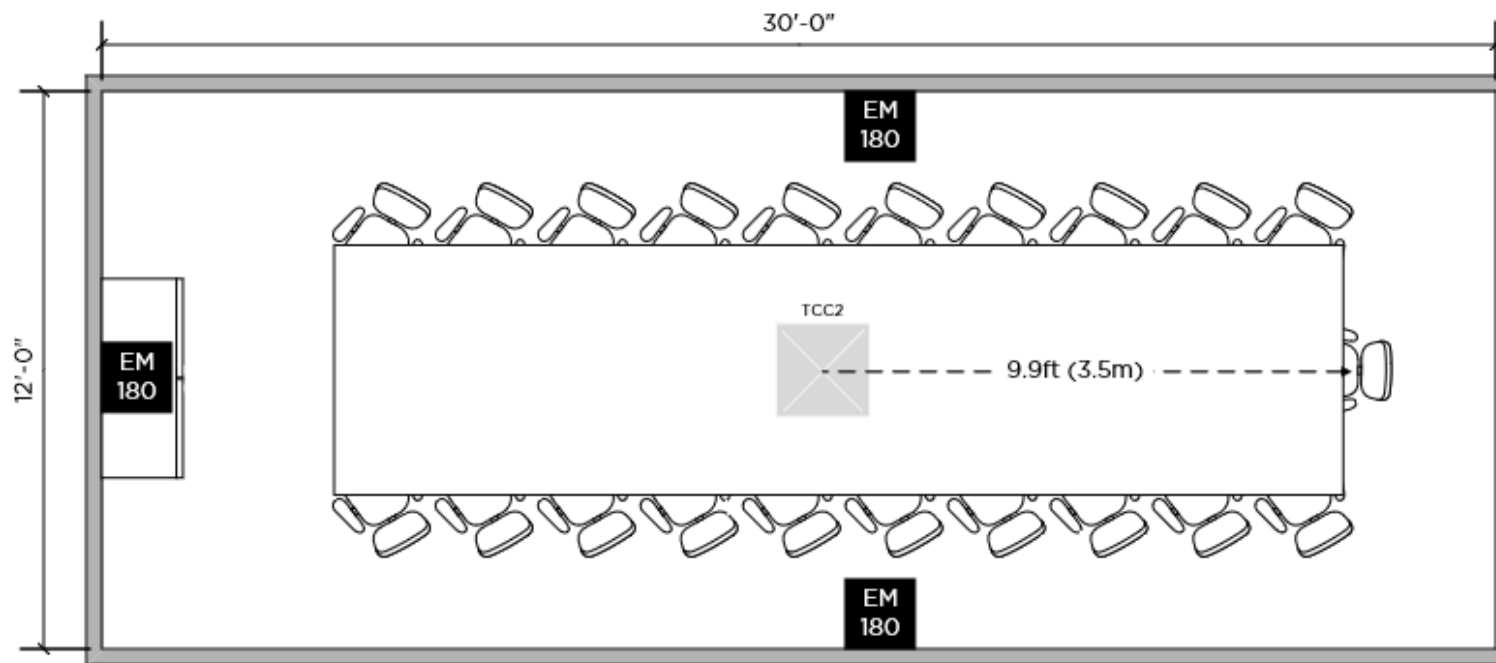

10ft Ceiling

Maximum distance to farthest listener: 4.5m (14ft)

Maximum distance to farthest talker: 3.5m (9.9ft)



Bose DS4 Ceiling Audio Solution

Microsoft Teams certified

**Certified for use with Avaya® and Cisco®
VoIP systems**

Integrated premium conferencing solution

- DM2C-LP loudspeakers
- Sennheiser TeamConnect Ceiling 2 microphone
- Bose amplifier and DSP

**Fewer devices and clutter — focus on
work**

Clarity and intelligibility in large rooms

Deploy quickly

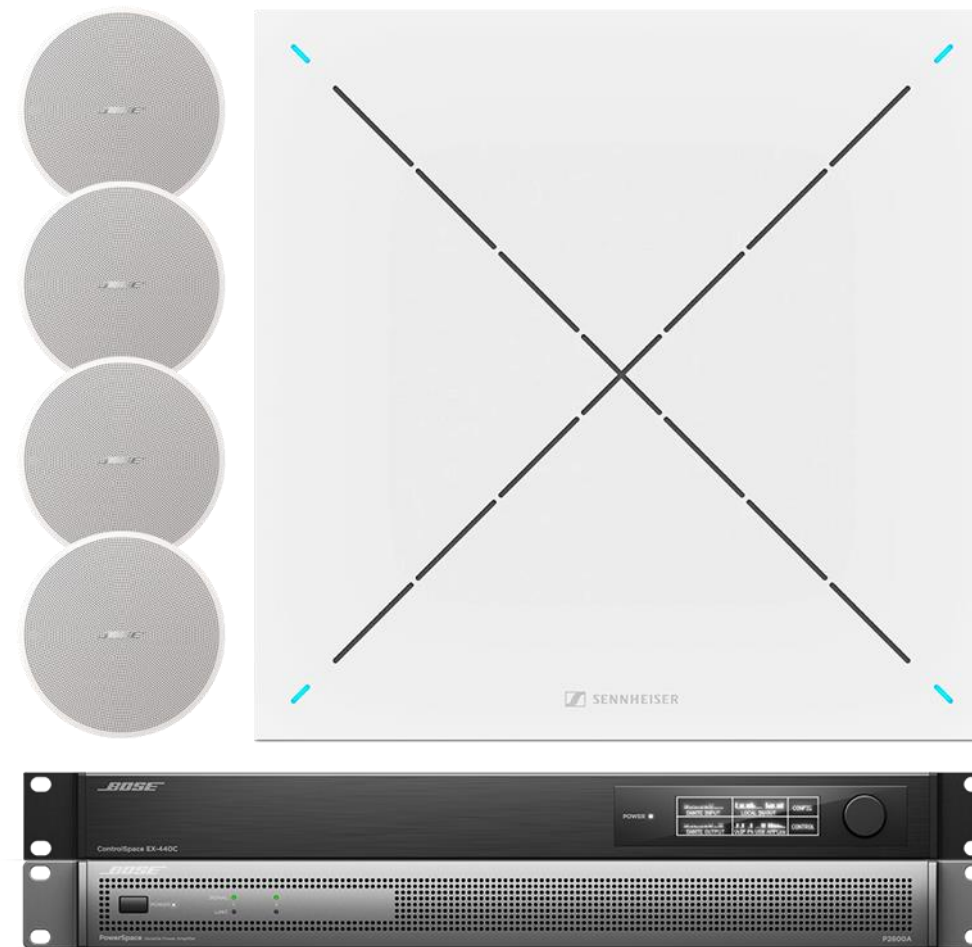

DesignMax DM2C-LP

Premium Audio and Aesthetics

True **Low-Profile** 10 cm (3.9") backcan

UL2043 steel plenum-rated backcan

16Ω, 70/100V

include adjustable tile-bridges in box



Conference Room Applications

Medium Conference Rooms

In medium conference rooms two DM2C-LP located above the conference table

DS4 system

Medium Conference Room

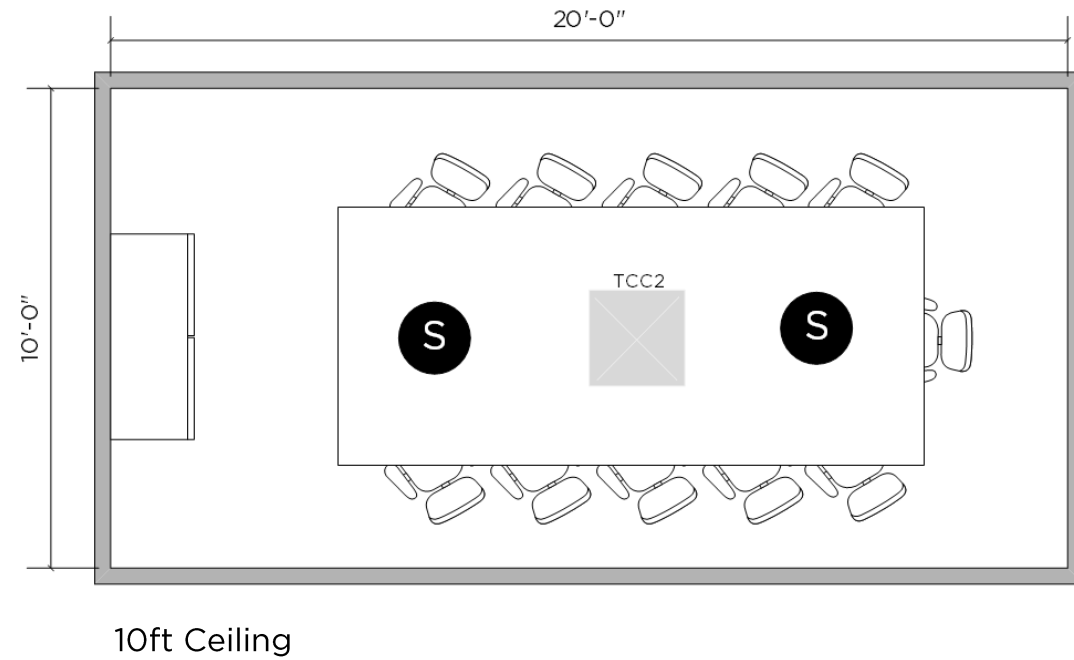

Conference Room Applications

Large Conference Rooms

In large conference rooms four DM2C-LP loudspeakers are located around the conference table

DS4 system

Large Conference Room

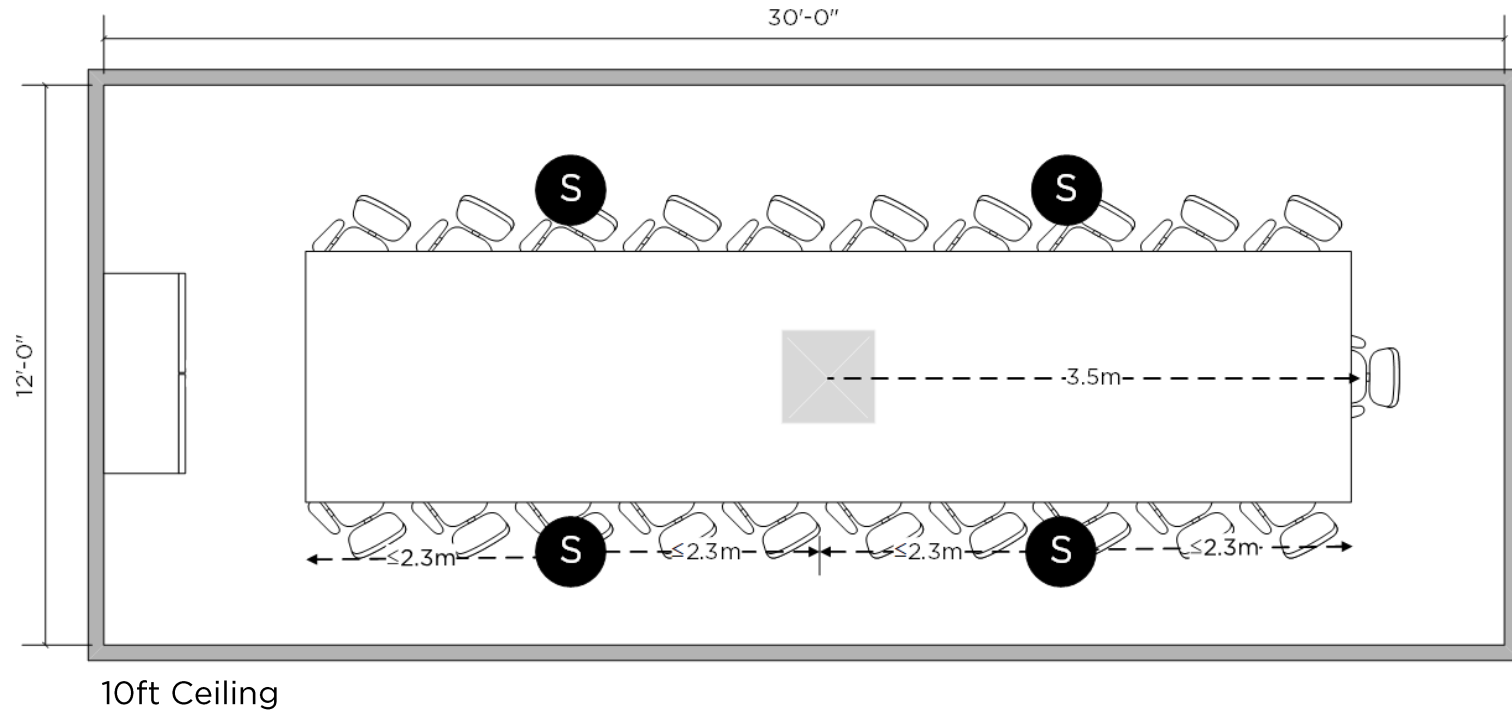

ControlSpace Conferencing Processors

Faster setup, fewer clicks,
better results

All-in-one design

Adaptable Noise Cancellation

8-Channels of AEC

Dante Audio Networking

GPI and Serial



ControlSpace EX-440C Conferencing Processor

P2600A PowerSpace Amplifier

2 Channel, 600W per Channel

Analog & Amplink Input

High Z & Low Z

Global Mute



PowerSpace P2600A Amplifier

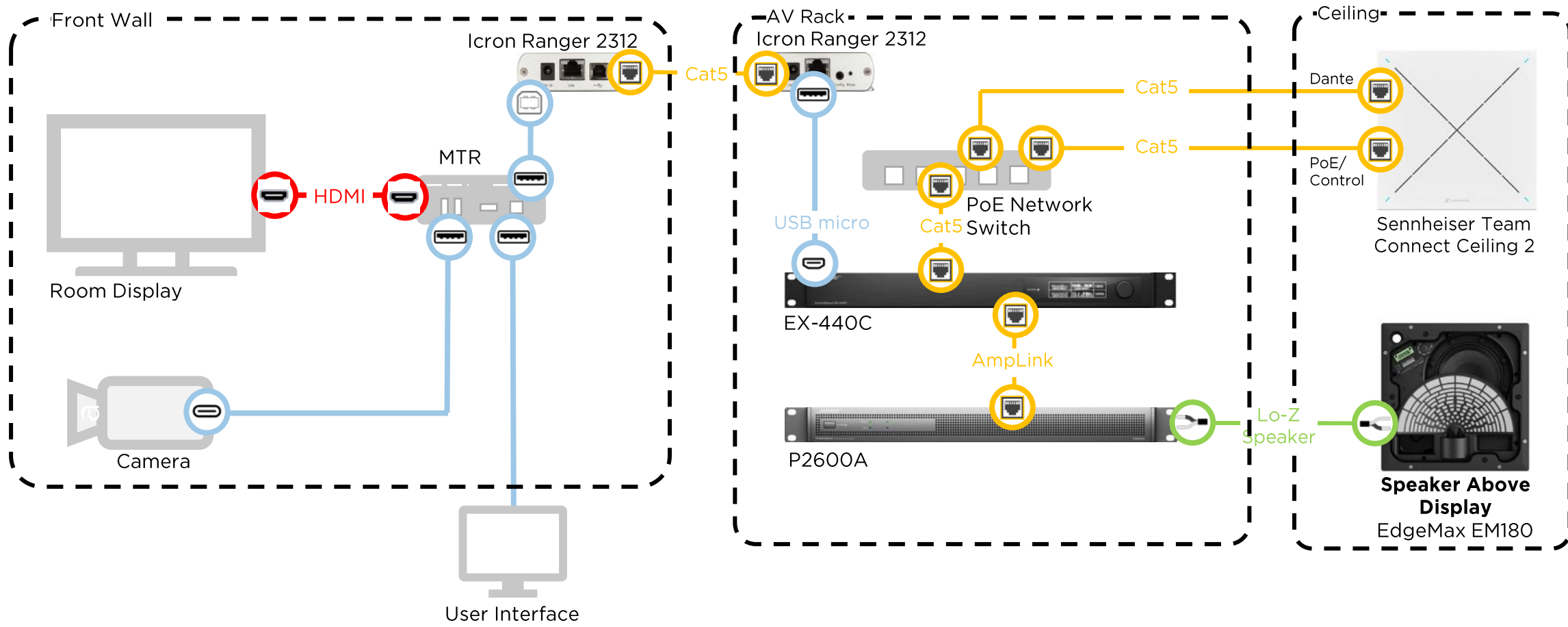

ES1 Wiring Diagram

PARTNER NETWORK

BARCO CLICKSHARE



Work Better. **Bose and Barco Clickshare**

For VB1, ES1 and DS4 Solutions

Bose Work Solutions are certified for use with Barco ClickShare Conferencing for easy, intuitive, and clutter-free meetings that make the era of hybrid work simply work for everyone.

Our products integrate seamlessly with existing platforms, bringing enhanced video and audio performance to popular third-party cloud services.

With Bose and Barco you get:

- Trusted solution from 2 premium brands
- A simplified conferencing experience
- Seamless integration with UC&C platforms
- Flexible, engaging solutions portfolio

Barco Clickshare Certified

Guaranteed Interoperability:

- Reduced cost deployment with less real-time engineering
- Continue to be plug-and-play as new features and capabilities are added to both ecosystems



CX-20**CX-30****CX-50**

Ideal for	Huddle Rooms and Carts	Meeting Rooms	Large Meeting Rooms and Boardroom
Included Buttons	1	2	2
Touch Display interactivity		●	●
Wireless BYOM Support	●	●	●
Concurrent Connectivity	Exclusive	Exclusive	Concurrent
4K UHD Output Resolution	●	●	●

Clickshare Conference Portfolio

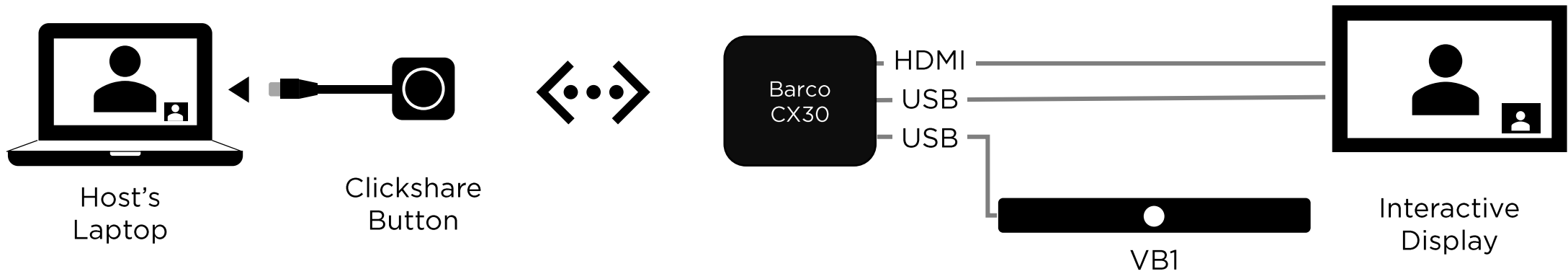
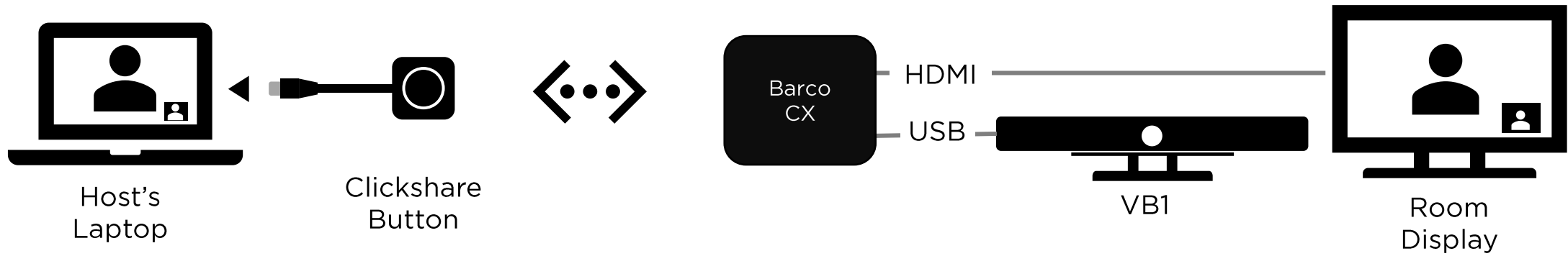

Clickshare Room Configuration Options

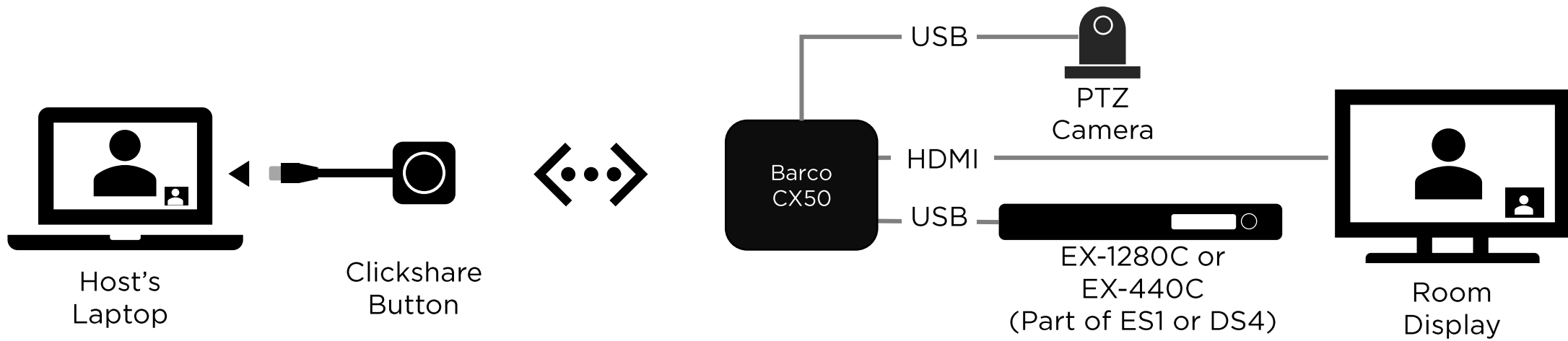

Clickshare Room Configuration Options

Barco Support

INSERT LOCAL REP CONTACT INFORMATION

MORE INFORMATION

To learn more about Bose Partners, contact us: [PRO.BOSE.COM/partner](https://pro.bose.com/partner) or email bosework@bose.com

HEWLETT PACKARD



Work Better. Bose and HP

For NCH 700 UC,
VB1, ES1 and DS4 Solutions

Now you can combine Bose Work products with HP Elite slide G2 Audio Ready for Microsoft Teams Rooms or Zoom Rooms to simplify meetings and seamlessly connect with an intuitive Center of Room Control.

With the Bose and HP solutions you can equip meeting rooms of all sizes and enjoy a trusted solution from two premium brands.

HP Elite Slice G2 Audio Ready – Overview

Any Sized Conference Room

- Small, medium, large, custom room types
- Integrates with 3rd party video & audio
- Up to two displays supported
- Two models for single and dual display

Flexible & Scalable

- Supports Microsoft Teams and Zoom Rooms
- Flexible deployment: on the table or behind the display

One Touch Collaboration

- High quality on-demand calling
- Dual viewing angles and share content wirelessly with one touch

Simple to Deploy, Manage & Secure

- Factory installed Microsoft Teams or Zoom Rooms Image
- Quick set-up-no assembly required.



For VB1, ES1 and DS4 Solutions

Bose Videobar™ VB1 with HP Elite Slice G2

For huddle spaces and small- to medium-sized conference rooms get Bose VB1 premium audio and video in a complete room solution.

The HP Elite Slice G2 Audio Ready is designed for huddle to medium size rooms, this device lets you simplify meetings and seamlessly connect with an intuitive Center of Room Control; provides flexible deployment & mounting options



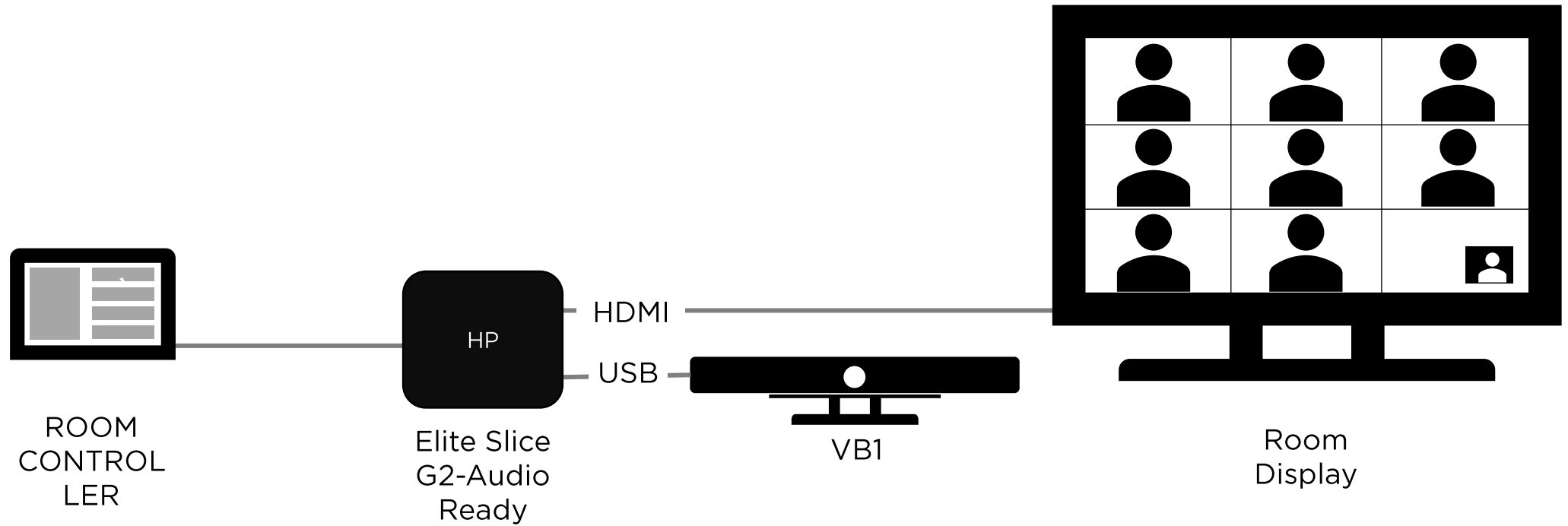

VB1: Small- to medium-sized room system

Bose Ceiling Audio Solutions with HP Elite Slice G2

For large or integrated meeting rooms, the HP Elite Slice G2 Audio Ready can be combined with either the Bose ES1 or DS4 ceiling audio solutions.

Keep microphones off the table and offer clear, intelligible audio to help meeting participants focus on what matters.



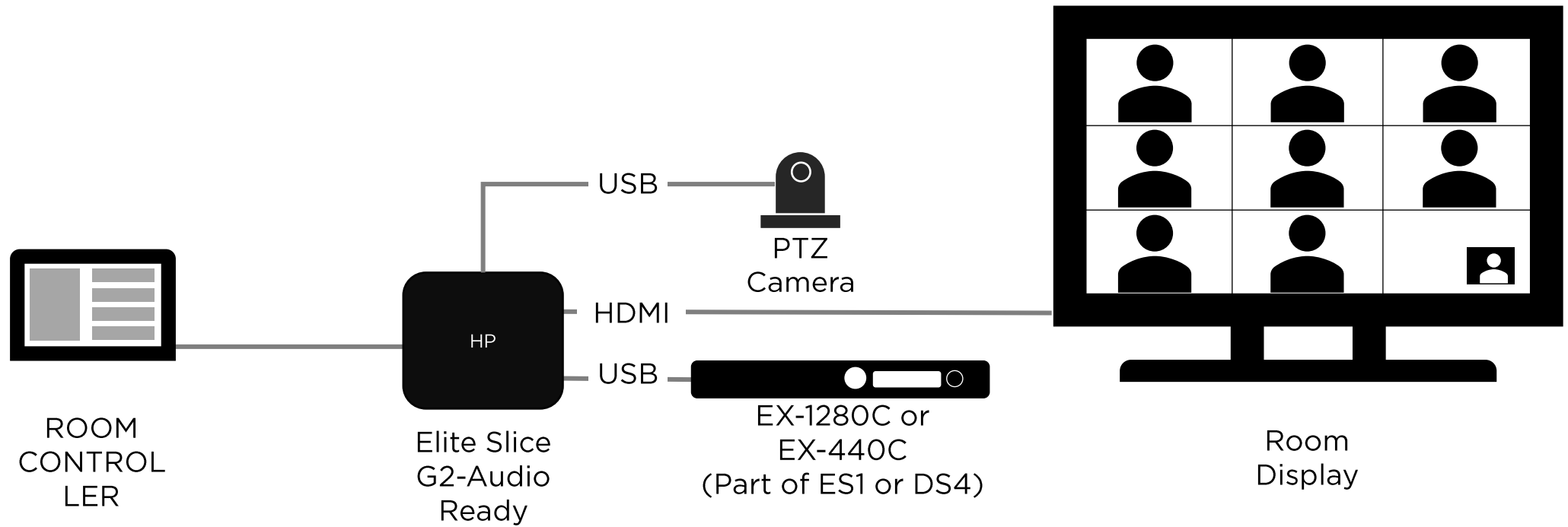

ES1/DS4: Medium to large-sized room system

HP Support

INSERT LOCAL REP CONTACT INFORMATION

MORE INFORMATION

To learn more about Bose Partners, contact us: [PRO.BOSE.COM/partner](https://pro.bose.com/partner) or email bosework@bose.com

HP Support

INSERT LOCAL REP CONTACT INFORMATION

MORE INFORMATION

To learn more about Bose Partners, contact us: [PRO.BOSE.COM/partner](https://pro.bose.com/partner) or email bosework@bose.com

Bose has joined the call.

PARTNER WITH US

With a global presence, including subsidiaries in 25 countries and comprehensive training — both online and in-person — we're ready to partner with you.

INSERT LOCAL REP CONTACT INFORMATION

CONTACT US TODAY

To learn more about the full range of Bose conferencing solutions, contact us: [PRO.BOSE.COM/contact](https://pro.bose.com/contact) or email bosework@bose.com



BOSE

THANK YOU