

6-FM-7

FM Series
Battery For General Use

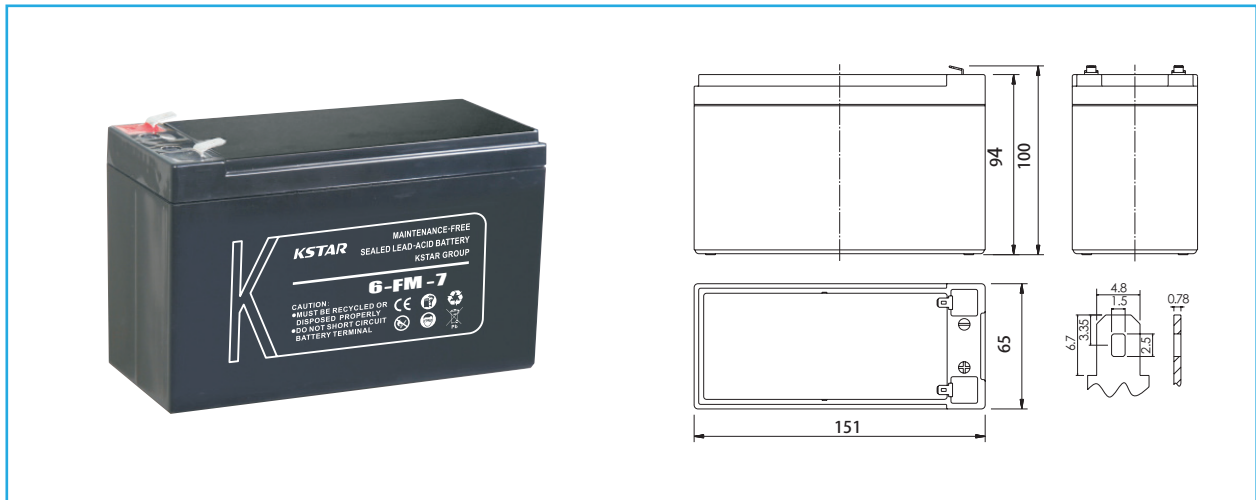

Specifications

Nominal Voltage	12V	
Rated Capacity (20 hour rate)	7.0Ah	
Dimensions	Total Height (with terminals)	3.94 inches(100mm)
	Height	3.70 inches(94mm)
	length	5.94 inches(151mm)
	width	2.56 inches(65mm)
Weight	Approx.4.84 Pound(2.20kg)	

Characteristics

Capacity 77°F (25°C)	20 hour rate (0.35A)	7.0 Ah
	10 hour rate (0.65A)	6.5 Ah
	5 hour rate (1.12A)	5.6 Ah
	1hour rate (4.20 A)	4.2 Ah
	15Minute Rate (12.3 A)	3.1 Ah
Internal Resistance	Full charged Battery 77°F (25°C)	26 MΩ
	104°F (40°C)	102%
	77°F (25°C)	100%
Capacity affected by Temperature (20hour rate)	32°F (0°C)	85%
	5°F (-15°C)	65%
	Capacity after 3 month storage	91%
Self-Discharge 77°F (25°C)	Capacity after 6 month storage	81%
	Capacity after 12 month storage	60%
	Max. Discharge Current 77°F (25°C)	105A(5S)
Terminal	F1 \ F2	
Charge (Constant Voltage)	Cycle	Initial Charging Current less than 2.1A Voltage 14.4~14.7 V / 77°F (25°C)
	Float	Voltage 13.5~13.8V / 77°F (25°C)

Discharge Curves 77°F (25°C)

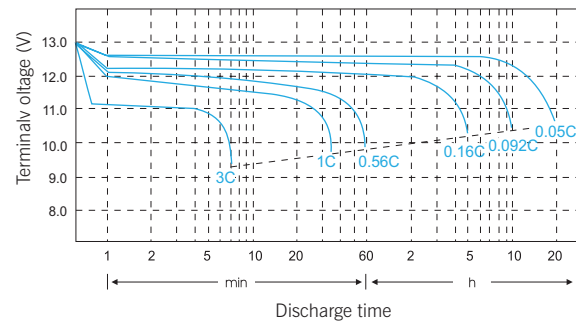

Relationship between charge voltage and temperature

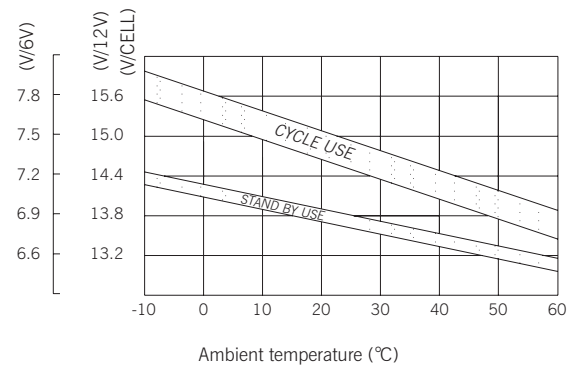

Constant Current Discharge (AMPERES @25°C)

F.V/Time	5Min	10Min	15Min	30Min	60Min	2H	3H	4H	5H	10H	20H
9.6	26.7	16.9	13.6	7.56	4.62	2.61	1.80	1.44	1.22	0.67	0.35
9.9	26.0	16.5	13.1	7.35	4.50	2.52	1.78	1.43	1.21	0.66	0.35
10.2	24.9	15.8	12.7	7.21	4.38	2.49	1.76	1.41	1.20	0.65	0.35
10.5	23.8	15.1	12.2	7.14	4.27	2.45	1.75	1.40	1.19	0.65	0.35
10.82	22.4	15.0	11.6	6.93	4.13	2.38	1.72	1.37	1.18	0.64	0.34

Constant Power Discharge (WATTS PER CELL@25°C)

F.V/Time	5Min	10Min	15Min	30Min	60Min	2H	3H	4H	5H	10H	20H
9.6	297	190	154	86.2	53.3	30.5	21.4	17.2	14.5	7.95	4.26
9.9	290	185	149	84.2	52.0	29.5	21.2	17.0	14.5	7.89	4.24
10.2	277	177	144	82.6	50.6	29.1	21.0	16.9	14.4	7.83	4.23
10.5	266	171	139	81.9	49.5	28.8	20.9	16.7	14.2	7.83	4.21
10.82	250	169	132	79.6	47.9	28.0	20.6	16.3	14.1	7.66	4.14

The operating environment temperature above 40°C should be avoided. After long term storage, The battery actual capacity would be less than the rated capacity. Full capacity will be obtained through several charge/discharge cycles. To get the longest life, KSTAR battery should be fully charged before storage.

Cycle service life in relation to depth of discharge

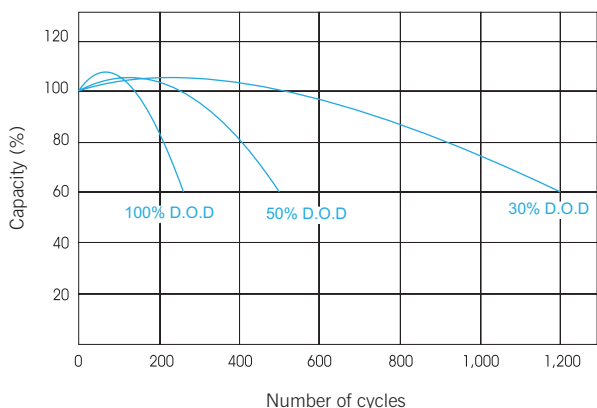

Constant voltage charge characteristic

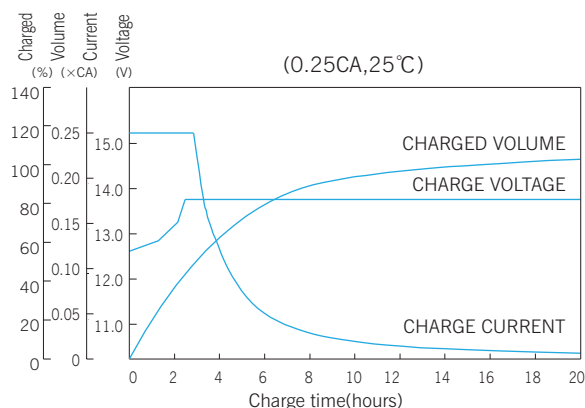

Self-Discharge Characteristics

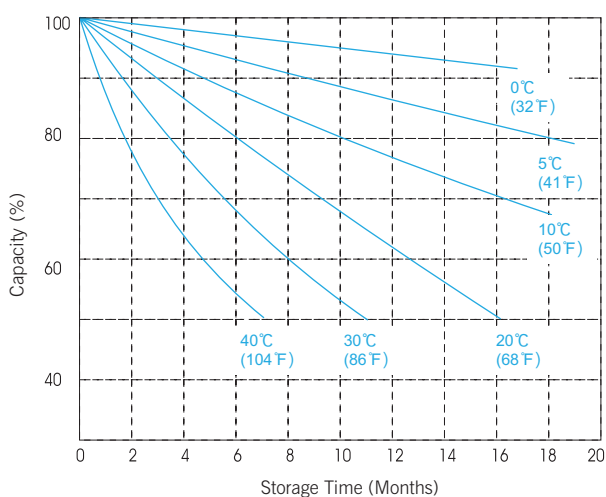

Relationship of OCV and Residual Capacity % (25°C)

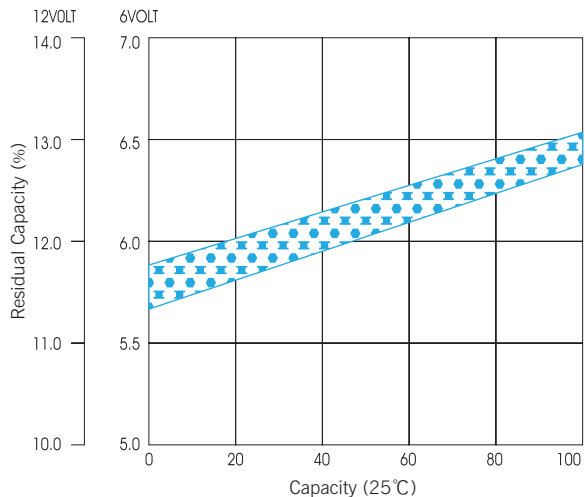

Temperature effects on capacity

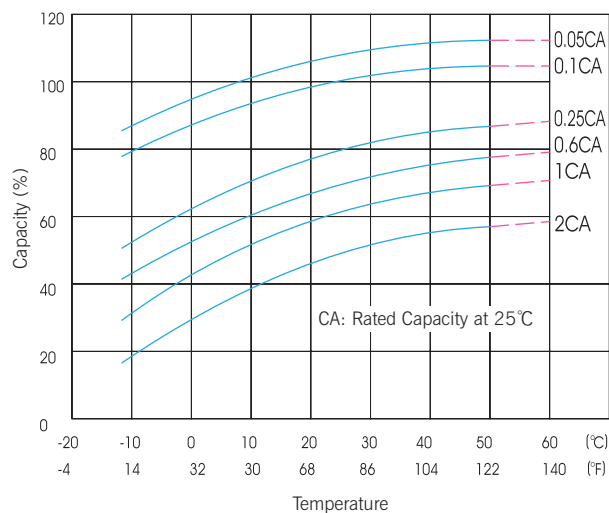

Temperature effects float life

